

IRIS-4 4 Series

Quick Installation and
Maintenance Guide

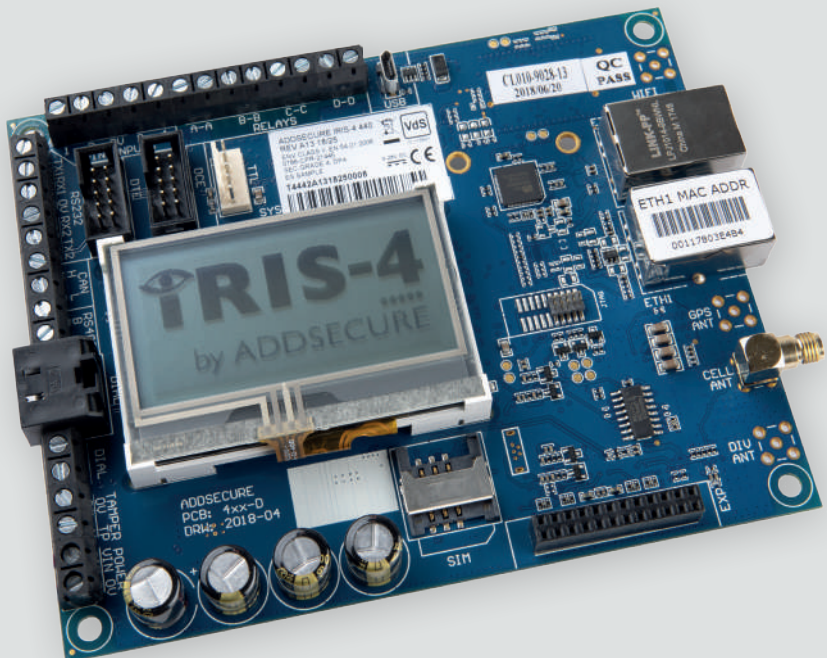

IRIS-4 4 Series

Quick Installation and
Maintenance Guide

CONTENTS

1. Introduction	3
2. Product Features	3
3. Package Contents	4
4. Board Configuration	4
5. Before You Start	5
6. Installing the IRIS-4 4 Series Dialler	6
6.1. Mounting	6
6.2. Power	6
6.3. Connections	7
6.4. 2/3/4G SIM card (IRIS-4 400 or 440)	8
6.5. Dial Capture	8
6.6. Pin Inputs	8
6.7. Expansion board (sold separately)	9
6.8. Switch On and Calibration	9
6.9. Configuration	9
6.10. Panel Configuration	10
6.11. Testing	11
7. Maintenance	11
7.1. Confirm Current Status	12
7.2. Check Software Version/Reflash	12
7.3. Communication Paths Checks	13
7.4. Test alarm panel alarms and communication to Monitoring Centre	13
7.5. Touch Screen Calibration	13
8. Specifications	14

I. INTRODUCTION

The IRIS-4 4 Series offers cost effective Alarm over IP (AoIP) for the commercial and residential sectors.

All IRIS-4 4 Series diallers are certified as suitable for all Grade 4 systems with an Alarm Transmission System (ATS) configuration up to SP6 for single path, or ATS configuration DP4 for dual path (IRIS-4 4 Series only).

The IRIS-4 4 Series is based on the successful IRIS Touch NG range of AoIP diallers with the same hardware and software used in all IRIS diallers; with the same level of security and features

provided to military, governments, banks and commercial industry markets.

It has a touch screen fitted as standard to allow configuration, get local alerts, and diagnostic/tests. Polling and alarm transmission are performed via the Ethernet or 2/3/4G communications to the monitoring centre using the IRIS Secure Apps monitoring software.

This manual gives a quick guide to the installation of products from the IRIS-4 4 Series. For the full engineering manual, including multi-lingual versions, please visit our website <http://www.addsecure.com>.

2. PRODUCT FEATURES

FEATURES	IRIS-4 4 SERIES		
	400	420	440
Touch Screen	•	•	•
Ethernet	—	2	2
2/3/4G	•	—	•
Dial capture	•	•	•
Relays	4	4	4
Inputs (Pins)	4 standard + 12 with add-on expansion board		
Serial RS485	•	•	•
Serial TTL	•	•	•
RS232 (Basic or Full)	1 x Full or 2 x Basic		
CAN bus	•	•	•
Text messaging	•	—	•
Multi language menus	•	•	•
VoIP & SIP services	•	•	•

IRIS-4 4 Series

Quick Installation and
Maintenance Guide

3. PACKAGE CONTENTS

Contents dependent on model type:

- Dialler board
- Ethernet cable (IRIS-4 420 & 440)
- 2/3/4G antenna (IRIS-4 400 & 440)
- Stylus for touch screen navigation
- RJ11 cable
- 18kΩ sense resistor for dial capture tamper detection

4. BOARD CONFIGURATION

- ① = RS232 x 2
- ② = CAN bus
- ③ = RS485
- ④ = Dial capture port
RJ11 and screw terminals
- ⑤ = External tamper
- ⑥ = DC power
- ⑦ = Touch screen
- ⑧ = SIM card holder
- ⑨ = Expansion board
connector
- ⑩ = 2/3/4G antenna
- ⑪ = Ethernet 1
- ⑫ = Ethernet 2
- ⑬ = SYS LED
- ⑭ = Serial (TTL)
- ⑮ = Micro USB
- ⑯ = Relays
- ⑰ = Pin inputs

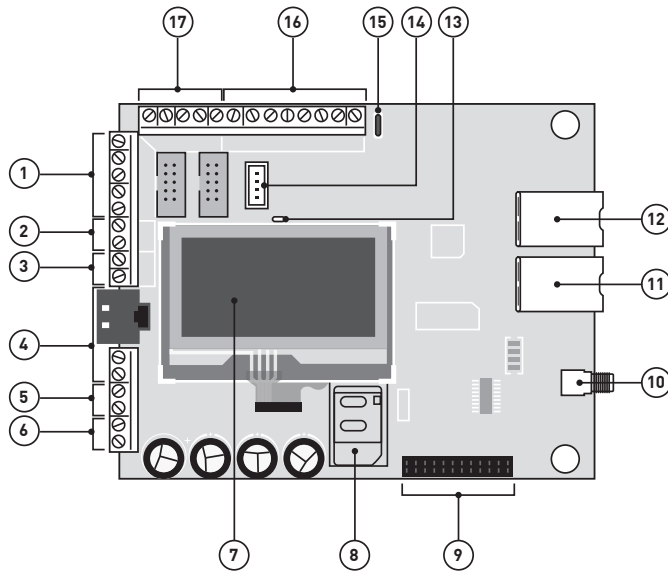

LED COLOUR	INDICATION
Yellow flashing	Not currently configured or indicating that there are some current faults outstanding
Yellow constant	Communicating and no current faults (flickers on every poll)

5. BEFORE YOU START

Monitoring Centre (ARC)

Make sure that the monitoring centre to which the IRIS-4 4 Series device will send alarm signals is equipped with the appropriate IRIS Secure Apps receiving system. The following information should be obtained from the Monitoring Centre.

Dialler account number:
Monitoring centre IP address:

Ethernet Connection Details

The customer's Ethernet (LAN) network details are required in order to connect the IRIS-4 420 & 440. Obtain the following information from the customer.

Fixed IP address or DHCP: Fixed DHCP

If using DHCP then the following information will not be required as it will be assigned by the network.

IP address:
Gateway address:
Subnet mask address:

2/3/4G SIM Card and Access Point Name

If the installation uses 2/3/4G then a SIM card will be required. The IRIS-4 400 & 440 will also need to be given a 2/3/4G 'Access Point Name' (APN) and other possible configurations as shown below. Obtain these from the SIM card provider.

Access Point Name (APN):
User name (USR):
Password (PWD):
SIM Pin:

IRIS-4 4 Series

Quick Installation and
Maintenance Guide

6. INSTALLING THE IRIS-4 4 SERIES DIALLER

Use the following procedure to install the IRIS-4 4 Series dialler:

6.1. Mounting

Choose a suitable location, taking into consideration the routing of both power and dialler interface cables, within the alarm panel or separate enclosure. Secure the dialler within the enclosure using the fitted stand-off or the alternative self-adhesive feet.

Note: For EN50131-10 compliance, the dialler must be mounted in an enclosure compliant with EN50131-3 or EN50131-6 and use the supplied standoffs and not the self-adhesive feet.

6.2. Power

The IRIS-4 4 Series dialler can be powered using a separate or Aux 9-28V DC power supply specified to deliver a minimum of 1A current using the screw terminals, or receive power directly via the 5 Pin Molex connector (Serial TTL) headers indicated in Section 4 “Board Configuration”.

Note: For Radio Equipment Directive compliance, the power cable must be no longer than 3 meters in length.

Fit the power cable. **DO NOT APPLY POWER TO THE DIALLER UNTIL INDICATED.**

6.3. Connections

Connect cables to the PCB for the system as shown on in Section 4 “Board Configuration”.

- Ethernet enabled systems (IRIS-4 420 & 440): Connect the ‘ETH1’ connector using the Ethernet cable to the local IP router/switch or socket that has been allocated for the LAN/WAN network IP connection.

- 2/3/4G enabled systems (IRIS-4 400 & 440): Fit the supplied T-bar 2/3/4G antenna to the ‘Cell Ant’ connector but do not fix in place until after performing the 2/3/4G network scan.
- Dial capture port (optional and for more information see section below).
- 4 x Pin Inputs + Expansion board (EXT1 or EXT2) for addition PIN inputs and PSTN dial out (optional and for more information see section below).

Optional serial connection

The following five connections are optional and depend on the panel connection method. By default, the IRIS-4 4 Series RS485 connection is for Honeywell Galaxy panels and the Serial TTL header is for Texecom Premier Panels.

Note: For alternative panel manufacturers’ selection, use the touch screen Installers menu - settings to select the option required. Please contact AddSecure for further details or download the full panel installation manual available from <http://www.addsecure.com>.

- RS485 currently available for Honeywell Galaxy data bus (Alarms and Upload/download) or Risco ProSys bus (Upload/download) connections (optional).
- Serial (TTL) currently available for Texecom Com1 connections (optional).
- RS232 port 1 screw terminal (optional for Hayes command terminal).
- RS232 port 2 screw terminal (optional for integrated panel connection).
- CAN bus screw terminals (optional).

For more details on the cable requirements/connections please see details on next page.

RS485 CONNECTIONS (HONEYWELL GALAXY OR RISCO PROSYS)

IRIS-4 4 Series to Honeywell Galaxy panels

IRIS RS485 screw terminals	To	Galaxy Data Bus terminal
0V (Power)	← →	Galaxy (-)
VIN (Power)	← →	Galaxy (+)
A	← →	Galaxy (A)
B	← →	Galaxy (B)

IRIS-4 4 Series to Risco ProSys panels

IRIS RS485 screw terminals	To	Risco Bus I terminal
0V (Power)	← →	COM
VIN (Power)	← →	AUX
A	← →	YEL
B	← →	GRN

TTL connections (Texecom Premier Range)

Ordered from AddSecure

Description = Texecom Serial Cable
Part No = TEX600

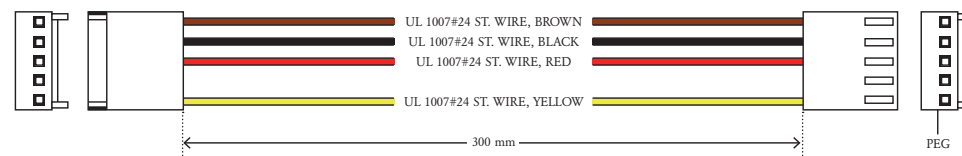

RS232 PORT 2 CONNECTIONS (HHL AND ESPA)

IRIS-4 4 Series to HHL panels

IRIS RS232 screw terminals	To	HHL Com Port (X3)
TX2	← →	2 (RX)
RX2	← →	3 (TX)
0V	← →	1 (GRD)

IRIS-4 4 Series to ESPA fire panels

IRIS RS232 screw terminals	To	DB9 Male connector (possible screw terminals)
TX2	← →	Pin 2 (RX)
RX2	← →	Pin 3 (TX)
0V	← →	Pin 5 (GRD)

IRIS-4 4 Series

Quick Installation and Maintenance Guide

6.4. 2/3/4G SIM card (IRIS-4 400 or 440)

DO NOT FIT SIM card until after you have performed the 2/3/4G Network Scan detailed in the Section 6.9 “Configuration”. You will be prompted when to insert the SIM card.

6.5. Dial Capture

Dial capture enabled systems: Connect either the dial port RJ45 or the two dial screw terminals with the supplied RJ11 dialler cable to the alarm panel dialler telecoms line connection. If the alarm panel has screw connections, cut the connector off the cable and strip the cable using the two inner wires.

Note: Polarity is not important in this instance.

For EN50136-2: 2013 compliance fit the supplied 18kΩ sense resistor in parallel with the dialler output of the alarm panel, at the alarm panel end of the cable.

Note: This resistor enables the dialler to detect cable faults and/or tampers, the Monitoring Centre will also need to enable the dial port monitoring on the IRIS Secure Apps software to receive alarm notifications.

6.6. Pin Inputs

The IRIS-4 4 Series dialler has four pin inputs that can be used to generate messages, if you require more than four pin inputs then you can fit the IRIS-4 4 Series expansion board (ordered separately). These can be:

- Text messages via SMS (IRIS-4 400 & 440 2/3/4G).
- SIA, Contact ID or Fast Format alarm messages over IP to the Monitoring Centre.

Note: You can also use the Pin alarm inputs when directly connected to an alarm panel via the dial capture, serial or RS485 connections.

Via Open/Close Contact Source

Each pin input is designed to be connected in a loop via an open/close contact source from an alarm panel, or other device, to a reference ground pin available on the IRIS-4 4 Series dialler, as shown below. Opening the contact (i.e. loop is open circuit) generates an alarm signal. Closing the contact generates the equivalent restore signal.

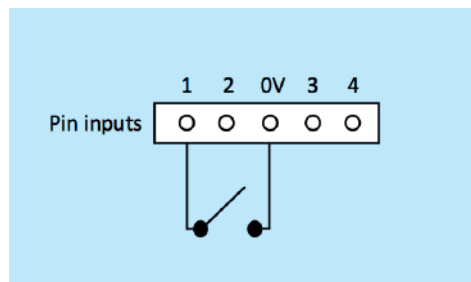

Via Sense Resistors

It is also possible to link the contacts to the IRIS-4 4 Series dialler via sense resistors so that an open or short circuit tamper on the loop is detectable and the Monitoring Centre alerted. In this case, the connections made should be as shown opposite.

Note: For this feature to work correctly it is essential to connect the resistor at the contact end of the loop and not the dialler end. The Monitoring Centre must also enable the monitoring of this facility on the dialler within the IRIS Secure Apps receiving system.

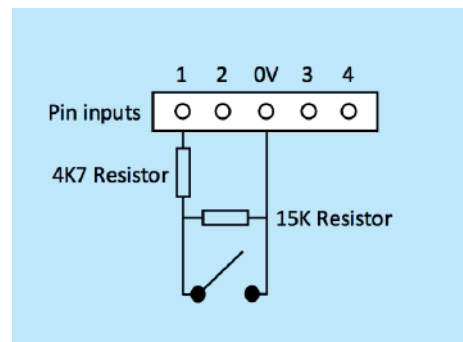

6.7. Expansion board (sold separately)

The IRIS-4 4 Series has the option to add one of two Expansion Boards detailed below, which gives the options for an additional 12 pin inputs and the option for a standard PSTN analogue line interface (PSTN as an outbound transmission path for alarms).

- EXT1 Pin inputs (12)
- EXT2 Pin inputs (12) + PSTN dial out

For further information on the Expansion Board, please refer to the IRIS-4 4 Series Expansion Board Quick installation guide from <http://www.addsecure.com>.

6.8. Switch On and Calibration

To confirm power is applied, look for the indicator ‘SYS LED’ flashing yellow on the IRIS-4 4 Series dialler board. Once powered on you will have a brief window to recalibrate the touch screen if required, press the ‘Touch Calibration’ box at the top of the screen and follow the onscreen prompts. For more information, see Section 7.5 “Touch Screen Calibration”.

6.9. Configuration

To configure the dialler, use any of the following methods:

- Touch screen.
- Alarm panel integration e.g. Honeywell Galaxy (RS485 connection) Texcom Premier range (Serial TTL connection).

Note: Please configure the alarm panel first for connections to Honeywell Galaxy or Texcom Premier on the serial integration, as these will transmit configuration to the IRIS-4 4 Series dialler. For more details on the alarm panel integration, download the full panel installation manual from <http://www.addsecure.com>.

- Connect the board’s Micro USB connector to a laptop/PC running the IRIS Toolbox software. Download the IRIS Toolbox user guide from <http://www.addsecure.com>.

Defaulting

If at any point a complete default of the dialler is required, use the following procedure:

1. Enter the Installer menu on the dialler touch screen and enter the installer password.
2. Go to the ‘Settings’ option and scroll down with the scroll bar on right until you see option for ‘Default All’.
3. Enter the ‘Default All’ and confirm that the dialler is to be defaulted.

Configuration via Touch Screen

IRIS-4 4 Series can be configured directly using the on board touch screen with the supplied stylus. Enter the default installer code: 111111 and then click ‘OK’. You will be prompted to change the password, please record the new password. Enter and confirm a new password and press ‘Save’.

IRIS-4 4 Series

Quick Installation and Maintenance Guide

The Main Menu is displayed.

Installers Password		
7 8 9	Delete	
4 5 6	Clear	
1 2 3	Cancel	
0	OK	

Installers Menu	
Installation Wizard	
Settings	
Test	
Run Network Scan	
Back	

IRIS-4 400 or 440 with 2/3/4G connection:

2/3/4G Network Scan

Select the 'Run Network Scan'. The scan must be carried out without the SIM card fitted.

The dialler listens for every base station in range, requests operator name and records the signal strength. This will take a few minutes to complete.

Scan In Progress Looking For Providers ...
--

Provider	Antenne	CSQ	
ALL	1	2	3
3 UK	31	31	31
vodafone U	31	31	22
EE	31	31	31
02 - UK	19	19	16
Back			

For a reliable 2/3/4G connection it is recommended that for the chosen network (SIM card) used there should be at least two base stations with signal strength (CSQ) of 10 or more.

If the signal strength is below or close to minimum then try to reposition the antenna or IRIS-4 4 Series dialler in a different location or you can use an external building or high gain antenna (if necessary), and rerun the network scan to check signal strength.

Once you have the required 2/3/4G signal strength power down the dialler and insert the SIM card into the SIM card holder, then power the dialler back up. Go back into the 'Installers Menu' and enter in the installer code that you had setup beforehand and then select the Installation Wizard as indicated next.

IRIS-4 420 or 440 without 2/3/4G or after network scan completed:

Installation Wizard

Select the Installation Wizard and follow the on screen prompts.

Installation Wizard	
Select interfaces	
Ethernet	<input checked="" type="checkbox"/>
2/3/4G	<input checked="" type="checkbox"/>
PSTN	<input checked="" type="checkbox"/>
Exit	Continue

Once Installation Wizard is completed and any additional panel interface configuration via the settings menu you will need to check/configure the panel for the connection method you are using:

6.10. Panel Configuration

Panel configuration for dial capture

If connecting the IRIS-4 4 Series dialler via the dial capture method which is connecting the Telecoms module of the panel to the dial port of the IRIS-4

4 Series, the following options will need to be configured:

Telephone Number = The 12 digit format of the Monitoring Centre IP address
(e.g. 192.168.0.34 would become 19216800034).

To select routing of an alarm over PSTN, place an extra digit "9" in front of the Tel 2 receiver telephone number. This tells the IRIS communicator that it should route the call over PSTN if available. If there is a PABX that requires a "9" to dial out of the site then place two '9's' in front of the Tel 2 number. Account Number: 4 - 6 digit account number allocated by the Monitoring Centre.

Note: If the 'Alarm override' mode is selected, the IRIS-4 4 Series dialler replaces the phone number and the account number used by the alarm dialler with the IP address of the Monitoring Centre and account number entered during configuration, so there is no need to change any settings on the alarm panel. If using the PSTN Expansion board do not use alarm override.

Alarm panel integration e.g. Honeywell Galaxy (RS485 connection) Texecom Premier range (RS232 TTL connection).

If you have not already made the changes to the relevant configurations in the panel for the integration, and require further details on these configurations then please download the full panel installation manual from <http://www.addsecure.com>.

6.11. Testing

Once all configurations are complete, perform a full commissioning test with the Monitoring Centre. This will normally involve testing normal alarm transmissions from the alarm panel over all communication paths to the Monitoring Centre and verifying acknowledgement of these alarms with the operators at the Monitoring Centre.

7. MAINTENANCE

There is no requirement for any onsite maintenance on the IRIS-4 4 Series.

If engineers want to carry out a maintenance inspection, please perform the following:

- Confirm the status of the IRIS-4 4 Series unit.
- Clear any faults on the dialler.
- Reflash IRIS-4 4 Series software to latest version.
- Test the configured communication paths (Ethernet and/or 2/3/4G).
- Perform full test of alarms from the alarm panel and confirm acknowledgement of these by the operators at the monitoring centre.

The IRIS-4 4 Series dialler will give a visual indication of the current system status via the 'SYS LED'. If this is yellow constant the current setup of the dialler is reporting OK, yellow flashing means the dialler is reporting some trouble events.

SYS LED:

 Yellow Constant = OK

 Yellow Flashing = Dialler is reporting some trouble events

IRIS-4 4 Series

Quick Installation and Maintenance Guide

To investigate any faults or to perform checks, the IRIS-4 4 Series dialler gives engineers the option via the touch screen, to see the current faults, reflash to latest software and perform communication path checks. Engineers will need to touch the screen to exit the screen saver mode and should now be presented with the welcome screen. Engineers will now see the option indicating status and the option to enter the installer menu. The engineer will now be able to perform the following checks:

7.1. Confirm Current Status

The IRIS-4 4 Series dialler will indicate “Status - ok” if the current dialler setup is all working correctly, and if the status is showing “Status - Trouble” the dialler has a trouble reported. To view the reported trouble click on the “Status - Trouble” option then “View Trouble Report”. Check the reported system troubles via the “Trouble report” menu.

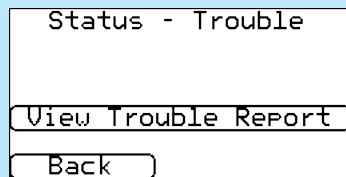

Please refer to the IRIS-4 4 Series Engineering Manual for more details available from <http://www.addsecure.com>.

7.2. Check Software Version/Reflash

Enter the ‘Installer Menu’, which will prompt for the installer code, check installation documentation to see what this is set to. Once in go to the settings menu and then scroll down and select the ‘Reflash’ option. On first entry to the reflash option, which could be during installation or maintenance, the engineer will be required to change the password as required for EN50136-2 compliance. Please record the password on the installation documentation. Enter the correct reflash password and you will then have the following options.

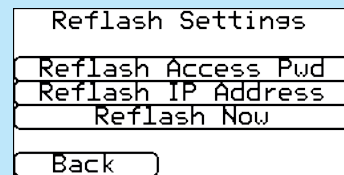

The AddSecure Reflash server IP address will already be setup under the ‘Reflash IP Address’ but if using an alternative Reflash IP address then change the IP address.

Once you have the correct reflash IP address entered press the ‘Reflash Now’ to connect to the server and check if there is a later version, and if there is, it will start to reflash.

The reflash will take up to 15 minutes if via 2/3/4G and approximately 2 minutes with the Ethernet connection. Once completed the dialler will reboot and switch to the new software.

Note 1: All configurations for the IRIS-4 4 Series dialler are stored and there is no need to reconfigure.

Note 2: During the reflash process, do not remove power until dialler has completed and reset.

7.3. Communication Paths Checks

The engineers can test the communication paths for both polling and alarm communications using the ‘Test’ option in the Main Menu. This will perform communication path checks for each path configured. Please refer to the IRIS-4 4 Series Engineering Manual for more details available from <http://www.addsecure.com>.

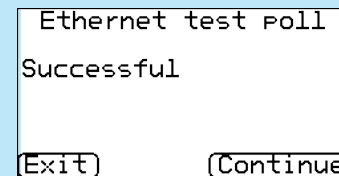

7.4. Test alarm panel alarms and communication to Monitoring Centre

Depending on the Monitoring Centre, engineers will now be required to perform alarm test and possibly other tests to the Monitoring Centre. Before the engineer leaves site get confirmation from the Monitoring Centre that all is working correctly.

7.5. Touch Screen Calibration

The IRIS-4 4 Series dialler allows Engineers to recalibrate the touch screen if required. To perform this you have two options as detailed below:

- On initial power on: ‘Touch Calibration’ box in the top part of the screen for a few seconds.
- In the Installer Menu > Settings > Display > Touch Calibration.

Press the ‘Touch Calibration’ box and follow the on screen prompts to calibrate the screen, as shown:

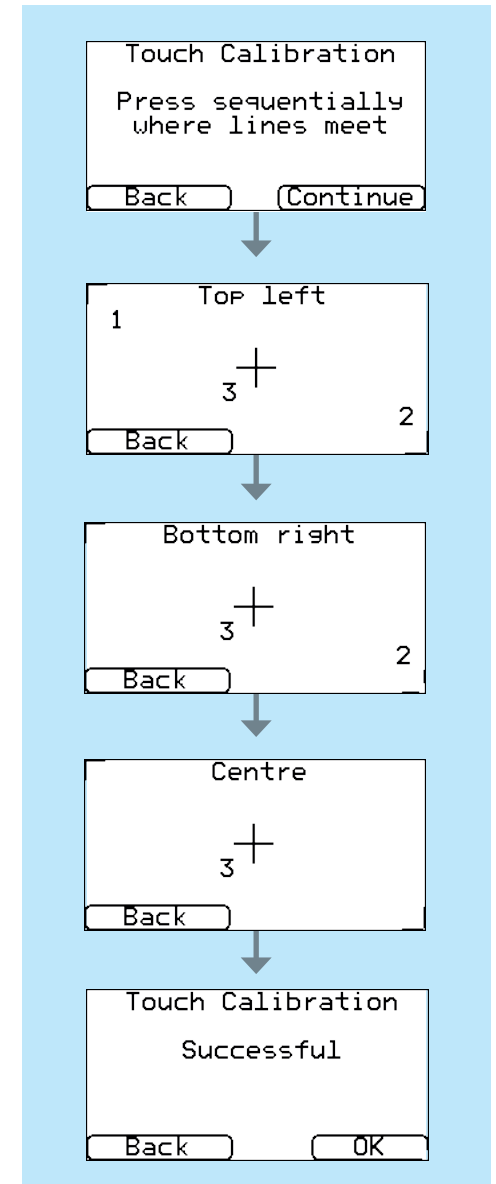

IRIS-4 4 Series

Quick Installation and
Maintenance Guide

8. SPECIFICATIONS

Transmission paths	400	420	440
Ethernet			
Standard	-	UTP 10/100 Base T with auto-negotiation	
Connection	-	RJ45 socket for CAT5 cabling	
IP addressing	-	Dynamic (DHCP) or fixed	
Fault detection	-	Loss of Ethernet synchronisation	
2/3/4G			
Frequencies	Penta band LTE (4G)		Penta band LTE (4G)
	800/900/1800 MHz		800/900/1800 MHz
	2100/2600 MHz		2100/2600 MHz
	Dual band UMTS (3G)	-	Dual band UMTS (3G)
	900/2100 MHz		900/2100 MHz
	Dual band GSM (2G)		Dual band GSM (2G)
	900/1800 MHz		900/1800 MHz
Connection	SMA socket for antenna	-	SMA socket for antenna
Fault detection	Loss of registration with network	-	Loss of registration with network
IP			
TCP ports (outbound)	53165 (Alarms & Polling), 51292 (Diagnostic & Reflashing), 10001 (Upload/Download)		
Alarm transmission			
Interface to Monitoring Centre	IRIS Secure Apps or IRIS Management Suite via EN 50136-2 pass-through mode		
Dial capture interface to alarm panel	Two wire interface via RJ45 socket or terminal block		
Serial interface to alarm panel	RS485, TTL, RS232 x 2 Note: RS232 cabling must not exceed 30 meters		
PIN Inputs interface to alarm panel	Maximum input voltage range 0V to +24V		Note: Cabling must not exceed 3 meters
	Input 'low' (alarm) threshold < 1V		
	Input 'high' (restore) threshold > 2V		
	Internal pull-up impedance 10K to 3.3V supply		

Transmission paths	400	420	440
Fault reporting to the alarm panel	If the dialler is unable to poll to the monitoring centre it reports this to the alarm panel using a method dependent on the panel interface mechanism: Dial capture: The line voltage is dropped to simulate loss of a PSTN connection. Serial: Either regular polls to the interface are ignored or an explicit message is sent to the panel, depending on the serial protocol in use. Pin inputs: A relay output can be set open to indicate fault.		
Alarm protocols	SIA (level 1 to 3) reference SIA DC-03-1990.01(R2003.10) Contact ID reference SIA DC-05-1999.09, Fast format (Scancom), Robofon (Dial capture only), Telim (Dial capture only) CESA (Dial capture only)		
Tamper detection reporting to Monitoring Centre	Dial capture interface, Serial interface, Pin inputs		
Fault reporting to Monitoring Centre	Transmission interface/path fault The IRIS dialler constantly 'polls' the monitoring centre to report it is operational and to report any interface or transmission faults it has identified. If the dialler has more than one transmission path then all paths are monitored and faults are reported by an operational path. If all paths or the dialler fail this is identified by the loss of polls. This allows the monitoring centre to monitor and calculate the dialler's availability.		
Substitution protection and information security	All transmissions are authenticated and encrypted using a unique 256 bit security key. This key is automatically updated every day.		
Relay outputs			
Maximum operating voltage	24V DC		
Maximum current rating	100mA DC		
Power supply			
Supply voltage	9V to 28V DC		
Typical current	151mA @ 12V DC	151mA @ 12V DC	153mA @ 12V DC
Maximum current	1A @ 12V DC		
Recommended external PSU	 12V DC 1A 12 Watt Note: For Radio Equipment Directive the power cable needs to be no longer than 3 meters in length		
Environmental			
Operating temperature range	-10°C to 55°C		
Operating humidity range	95% max, non-condensing		
Weights and dimensions			
Physical dimensions	15 cm x 11 cm		
PCB weight	300 grams		
Fully packaged weight	500 grams		

SAFETY

Care should be taken when connecting telecommunications equipment to ensure only like interfaces are connected to avoid safety hazards.

SELV: SELV (Safety Extra-Low Voltage) is defined as a secondary circuit which is so designed and protected that under normal and single fault conditions the voltage between any two accessible parts does not exceed a safe value (42.4V peak or 60V dc maximum)

The interfaces on the IRIS-4 4 Series have the following safety classifications:

- Dial capture interface: SELV suitable for connection to the TNV interface of single line telecommunications equipment such as telephones, alarm panels, etc.
- Power Interface: SELV for connection to a DC supply
- Inputs: SELV for connection to alarm output pin.

CONFORMANCE

European Directives

The IRIS-4 4 Series complies with the following European Directives:

- 2014/53/EU (Radio Equipment Directive)
- 2013/35/EU (Electromagnetic Fields)
- 2004/108/EC (CE directive)
- 2002/96/EC (WEEE)
- 2011/65/EC (ROHS)

CONTACT AND SUPPORT

Installation and Service Engineer Support Telephone: +44 871 977 1133

(Calls are charged 13 pence per minute plus your phone company's access charge)

Sales enquiries: +41 435 080 870

Email: iris.support@addsecure.com

www.addsecure.com

The information contained is supplied without liability for any errors or omissions. No part may be reproduced or used except as authorized by contract or other written permission. The copyright and foregoing restriction on reproduction and use extend to all media in which the information may be embedded.

© 2018 AddSecure



EN50131, EN50136 (VdS Certified)

The dialler is compliant with the requirements of European Standards:

EN 50131-1: 2006+A2:2017 & EN 50131-10:2014

EN 50136-1: 2012 & EN 50136-2: 2013

Security Grade 4

ATS-SP6 over Ethernet, ATS-SP5 over 2/3/4G, ATS-DP4 (IRIS-4 440)

When using PSTN ATS-SP2 over PSTN, ATS-DP1 (IRIS-4 440)

Environmental Class II

EN54-21 CPR (VdS Certified)

EN54-21 CPR fire approved

